



# Stairfriend Stairlift



## Owner's Manual

(To Be Retained by Owner After Installation  
by Authorized Savaria Dealer)

Part No. 000914  
11-m08-2020

---

---

## IMPORTANT - READ FIRST

Ensure that only an authorized Savaria mechanic installs and services your Lift. Under no circumstances is anyone other than a mechanic with Savaria training and authorization to install, adjust, service or modify any mechanical or electrical device on this equipment.

Failure to follow this warning can result in safety system compromises or defeat; this can result in serious injury or death. Savaria accepts no liability for property damage, warranty claims or personal injury, including death, in this circumstance.

Passenger safety is the result of countless details in the equipment design, manufacture, and installation. After installation, reliable operation and continual safe operation requires regular inspection and maintenance as outlined in this manual, or more frequently where usage, environment, or local jurisdiction requires. As the Owner, you are responsible for ensuring that regular inspections and maintenance occur in a timely manner as per the manufacturer's recommendations and maintenance schedule.

Refer to this owner's manual for unit description, setup, operating instructions, and a maintenance schedule for your Lift. Upon completion of installation, the Savaria mechanic must provide you with the information for the box below and ensure it is recorded in this owner's manual. In addition, either you or the Savaria mechanic must keep any service and/or maintenance records in the Maintenance Record section of this owner's manual.

At all times, your Lift must be maintained in compliance with the applicable standard to which it has been built and installed.

- United States - A18.1 – Safety Standard for Platform Lifts and Stairway Chairlift
- Canada - CSA B355/613 – Platform lifts and stair lifts for barrier-free access
- Europe - EN-81-40 – Stairlifts and inclined lifting platform intended for persons with impaired mobility
- Europe - 2006/42/EC – Machinery Directive

Depending on your country or region, the local authority code variant may apply.

To ensure safe operation of your Lift, pay careful attention to the important notes, and follow the instructions and any additional safety regulations in this manual.

### FOR OWNER'S RECORDS

Customer Name: \_\_\_\_\_

Installing Dealer: \_\_\_\_\_

Dealer's Telephone Number: \_\_\_\_\_

Date Installed: \_\_\_\_\_

Serial/Job Number: \_\_\_\_\_

---

## WARRANTY

Ensure your Savaria Dealer provides you with a copy of the manufacturer's limited parts warranty and documentation relating to any Dealer labour warranty.

-----

## CONTENTS

TO ENSURE SAFE OPERATION .....	4
1. DESCRIPTION .....	5
2. SPECIFICATIONS .....	7
3. FEATURES .....	8
Seating Features .....	8
Safety Features .....	9
Footrest and Carriage Sensors .....	9
Safety Switches .....	9
Emergency Stop Button (Optional) .....	9
Overspeed Governor .....	9
Key Switch and Power Switch .....	10
4. OPERATION .....	11
Before Operating the Stairlift .....	11
Operating the Stairlift .....	12
Emergency Stop .....	13
Emergency Manual Operation.....	13
5. ADJUSTMENTS .....	14
Seat Adjustment (V-Seat) .....	14
6. TROUBLESHOOTING AND MAINTENANCE .....	15
Operator Troubleshooting .....	15
Stairlift Will Not Run .....	15
Stairlift is Beeping .....	15
Stairlift Stops and Won't Restart.....	15
Diagnostic LEDs .....	16
Maintenance .....	17
Maintenance Record .....	18

## TO ENSURE SAFE OPERATION

To ensure safe operation of this equipment, pay careful attention to the important notes below.

To ensure safe operation of this equipment, pay careful attention to the important notes below.

To ensure safe operation of this equipment, pay careful attention to the important notes below.

To ensure safe operation of this equipment, pay careful attention to the important notes below.

To ensure safe operation of this equipment, pay careful attention to the important notes below.

- Read this manual carefully before using the equipment.
- To prevent accidents, adhere strictly to the instructions and keep clear of moving parts at all times.
- Follow instructions on all equipment labels at all times. Replace any damaged labels immediately.
- Ensure that only qualified personnel perform maintenance and service on the unit.
- When replacing parts, be sure that only genuine Savaria parts are used.
- This unit is intended for use by a mature person who understands its proper operation as set out in this manual.



**At no time should children under the age of 16 use the lift while unsupervised.**

- This lift is to be used ONLY for the transport of a person up/down the stairway. Do NOT use the lift for any other purpose (such as the transport of items).
- Do NOT use the lift for firefighting purposes or for evacuation during a fire.
- Prior to operation, make sure that all areas in and around the lift are clear of any obstructions.
- Be very careful of others using the stairs while the lift is in operation as

## 1. DESCRIPTION

Figure 1 shows the exterior components of the Stairfriend with V-seat.

**Figure 1**

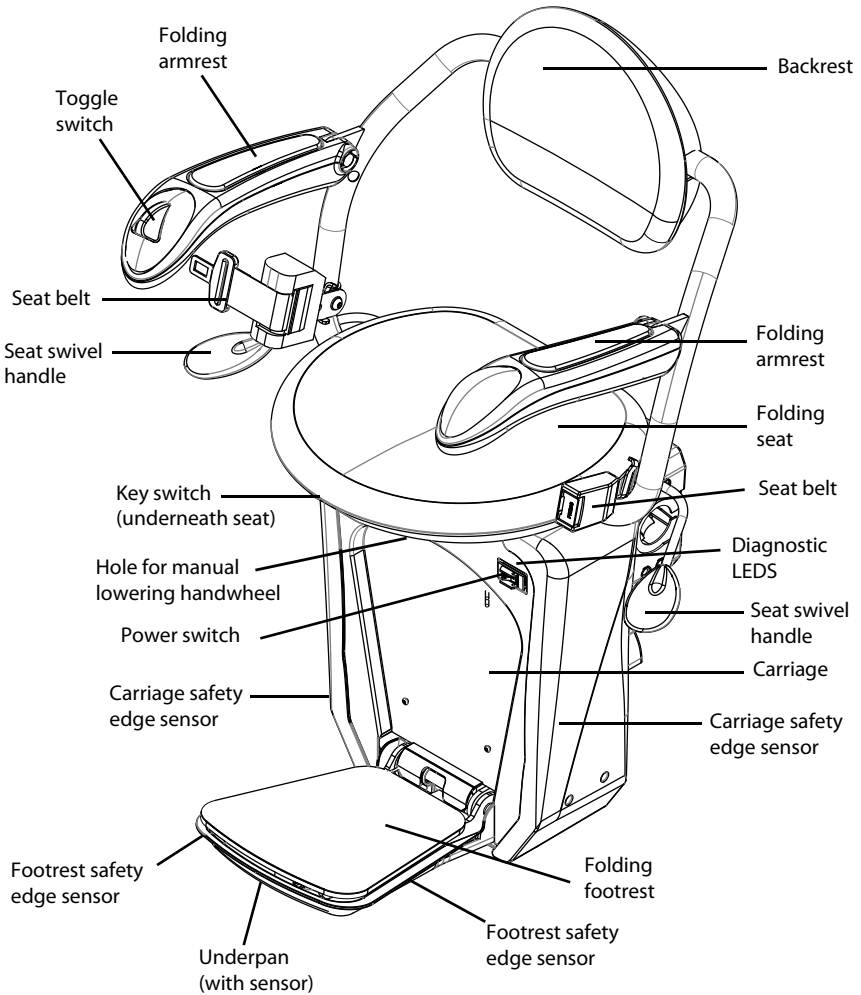
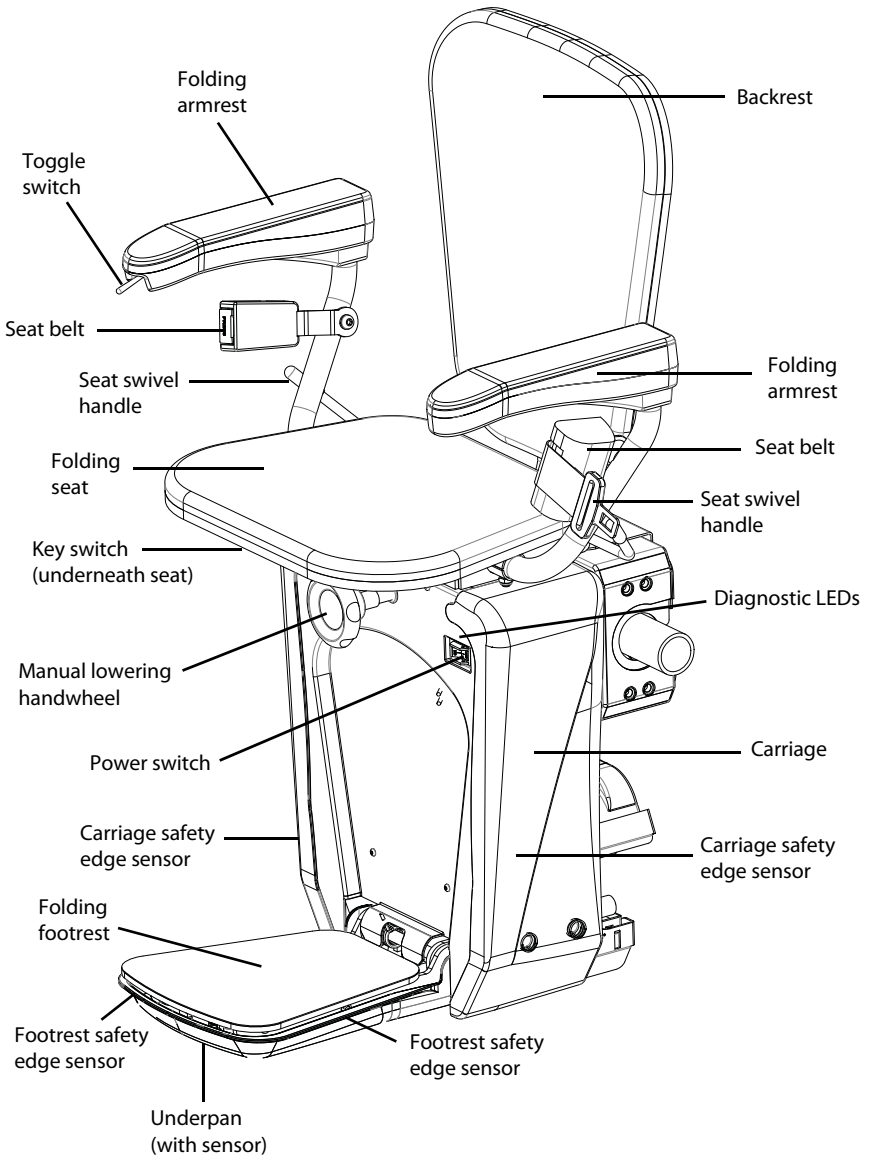

Figure 2 shows the exterior components of the Stairfriend with L-seat.

**Figure 2**



## 2. SPECIFICATIONS

### Stairfriend Specifications

Applications	Residential, indoor, curved stairs Commercial - varies by region; contact your authorized Savaria dealer for details
Load capacity	350 lb (160 kg)
Maximum travel	84 ft (25.6 m)
Travel speed	20 ft/min (0.1 m/s); 12 ft/min (0.06 m/s) at bends
Daily cycle	Normal: 10 Heavy: 30 Excessive: 50 Maximum starts in 1 hour on standard installation: 5
Range of incline	0° to 52°
Drive system	Rack and pinion
Operator controls	Constant-pressure type (toggle switch and remote control call/send units)
Seat belt	Retractable
Motor	1/2 HP, 24 VDC
Charging	Charges on standard household power (110 VAC) at landings
Fold-up width	15.5" (39.4 cm)
Fold-out width	25.5" (64.5 cm)
Rail	Steel
Emergency operation	Full up and down travel on power interruption (full battery backup)
Options	Savaria Link remote monitoring
Warranty	36 months parts, ask dealer for details

## 3. FEATURES

### Seating Features

The seat assembly can swivel in either direction for transfer in/out of the seat. Lift up and hold the swivel handle to swivel the seat. Let go of the handle and the seat will lock in place. **For your safety, do not swivel the seat until the unit has stopped.**

When the stairlift is not in use, the seat, armrests, and footrest can be folded up to allow for more space on the stairway.

Always use the retractable seat belt to ensure that you are safely secured in the chair during travel.



---

## **Safety Features**

### **Footrest and Carriage Sensors**

There are safety edge sensors on the sides of the footrest and the carriage, and an underpan sensor on the bottom of the footrest. These sensors will stop the stairlift if an obstruction is encountered on the stairway.

If you encounter an obstruction, press the opposite side of the toggle switch to run the stairlift in the opposite direction. Remove the obstacle from the pathway and proceed in the original direction of travel.

### **Safety Switches**

There are upper and lower safety limit switches to stop the stairlift when it reaches the top or bottom of the stairway. There are also mechanical stops at the top and bottom of the rail to stop the lift from running off the rail.

There is also a safety switch for the swivel seat that will prevent the stairlift from running if the seat is not locked in the riding position.

### **Emergency Stop Button (Optional)**

There is an optional emergency stop button that may be located on the arm. Pressing this button will stop the unit immediately.

### **Overspeed Governor**

There is an overspeed governor that will engage and stop the lift if the normal downward travel speed is exceeded.

## Key Switch and Power Switch

The stairlift is equipped with a key switch underneath the seat (see Figure 3). The stairlift cannot be operated unless the key is inserted and turned to the ON position. Once the key switch is turned on, flip the red ON/OFF power switch located on the front top left of the carriage to the ON position.

**Figure 3**

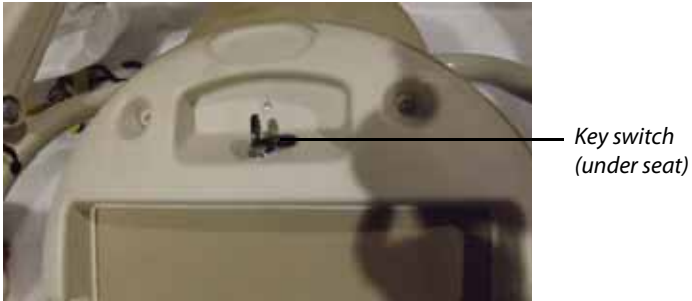

---

## 4. OPERATION

### Before Operating the Stairlift

- 1 Ensure the stairway is clear of any obstructions and the stairlift charger is plugged in at the wall.
- 2 Insert the key and turn it a quarter turn clockwise. Flip the ON/OFF power switch to the ON position.
- 3 Check that the seat is locked in the riding position for up/down travel.

#### NOTE

*If the chair has not been used for over an hour, press the remote button twice to wake it from sleep mode. If the chair has not been used for over 24 hours, run the chair from the arm toggle switch for a second to wake it from sleep mode. You can then use the remotes for normal operation.*

## Operating the Stairlift

- 1** Use one of the remote control CALL/SEND units to move the stairlift to the required end of the rail. Be sure to point the remote at the lift when pressing the button.
- 2** If necessary, fold down the seat, armrests, and footrest.
- 3** Lift up the seat swivel handle, rotate the seat to a comfortable boarding position, and then release the swivel handle to lock the seat in place.
- 4** Position yourself in the seat and fasten the seat belt.
- 5** Lift up and hold the seat swivel handle and rotate the seat so you are parallel to the rail (with your back against the stairway wall). Release the swivel handle to lock the seat in the riding position.
- 6** Place your feet securely on the footrest and your arms on the armrests.
- 7** Press and hold one end of the toggle switch to move the stairlift in the desired direction.
- 8** The stairlift will stop automatically at the upper or lower end of the rail, or if the toggle switch is released.
- 9** Once the stairlift has come to a complete stop, swivel the seat as required. When the seat is locked in place, unfasten the seat belt and get out of the chair.
- 10** To allow for more room on the stairway when the stairlift is not in use, swivel the seat back to the riding position, and then fold up the seat, armrests, and footrest.

## Emergency Stop (Optional)

In the event of an emergency, you can press the optional red Emergency Stop button located on the arm of the chair. The stairlift will stop immediately. Once the emergency is dealt with, release the button to restore normal operation.

## Emergency Manual Operation

The emergency manual lowering tool (handwheel) allows you to operate the lift manually.

### NOTE

*The batteries must be connected to release the motor brake and then you can use the manual hand crank.*

- 1 Turn off power at the stairlift and unplug the power cord from the wall.
- 2 Remove the rubber cover from the hole on the top front of the carriage.
- 3 Fit the shaft of the manual lowering handwheel onto the motor input shaft.
- 4 Rotate the tool **clockwise** for the unit to travel **up** the stairs and **counter-clockwise** for the unit to travel **down** the stairs.
- 5 When complete, remove the tool and insert the rubber plug back into the hole.

**Figure 4**

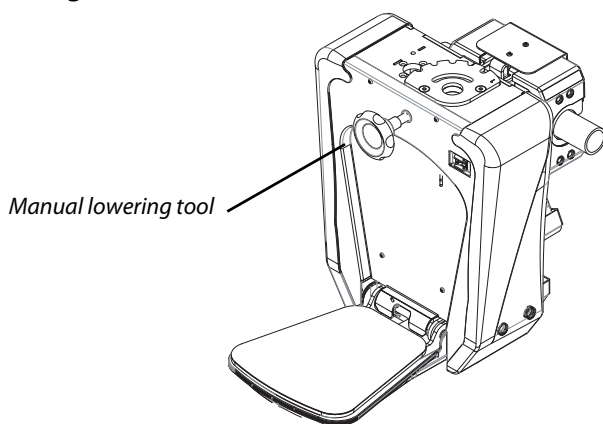

## 5. ADJUSTMENTS

### Seat Adjustment (V-Seat)

If the seat will not stay folded up when the stairlift is not in use, perform the adjustment procedure below.

- 1 Lift up the seat and loosen the two lock-nuts as shown below.
- 2 Using an Allen key, tighten the set-screw in each lock-nut as shown below.
- 3 After tightening the set-screws, move the seat to ensure it will remain in the folded position.
- 4 Tighten the two lock-nuts.

**Figure 5**

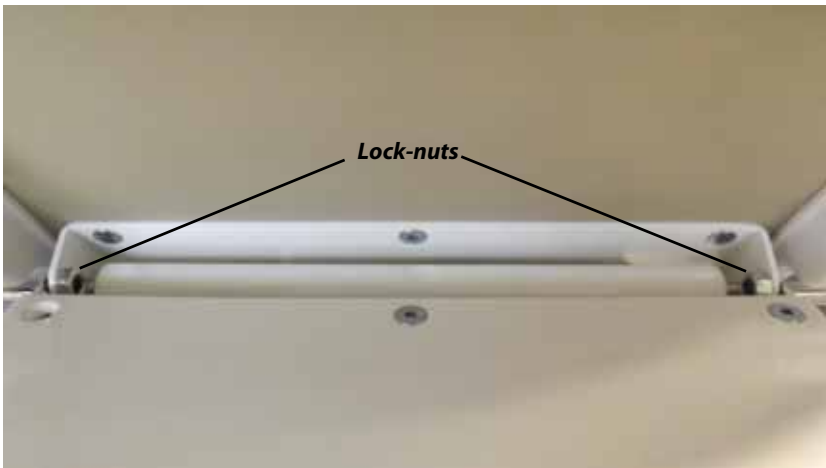

---

## 6. TROUBLESHOOTING AND MAINTENANCE

### Operator Troubleshooting

#### Stairlift will not run

If your stairlift will not run and no lights are on, check the items listed below.

- 1 Make sure the stairlift charger is plugged in at the wall.
- 2 Make sure the key switch is turned ON and the power switch is ON.
- 3 Check the residence main circuit breaker (or fuse) panel for a tripped breaker tripped or blown fuse?

If your stairlift does not operate and all of the lights are on, check the items listed below.

- 1 Make sure the seat is swiveled and locked in the riding position.
- 2 Check around the footrest and carriage for any obstructions.

If the stairlift does not operate after checking the above items, contact your authorized Savaria dealer.

#### Stairlift is beeping

If the stairlift beeps for approximately 20 seconds while not moving, this means the stairlift is not charging.

Check that the stairlift cord is plugged in to the wall outlet.

Make sure the stairlift is either all the way up or all the way down at the charging contact. It will beep continuously if it is not at a charging contact.

If the beeping continues, contact your authorized Savaria dealer.

#### Stairlift stops and won't restart

If the stairlift runs to either end of the stairway and then stops and won't restart, this means that the battery charge is low.

Charge the stairlift.

If the problem continues, contact your authorized Savaria dealer.

## Diagnostic LEDs

There are three diagnostic LEDs located above the power switch on the carriage front panel as shown below.

**Figure 6**

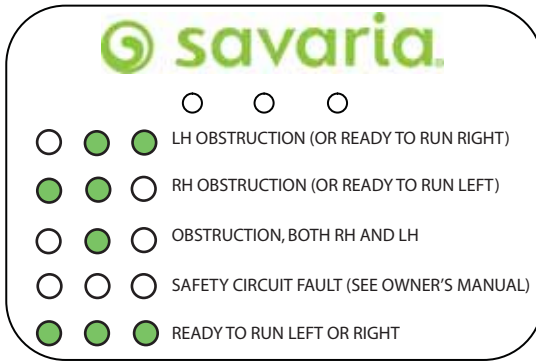

### LED Status

LEDs	Meaning
Middle and right LEDs on	Left-hand obstruction (or ready to run right)
Middle and left LEDs on	Right-hand obstruction (or ready to run left)
Middle LED on	Obstruction, both right-hand and left-hand
All LEDs off	Safety circuit fault
All LEDs on	Ready to run left or right



## Maintenance

### NOTE

The owner can perform the 3-month checks; 6-month checks **must** be performed by a qualified technician. Contact your Savaria dealer.

Units installed in adverse environments will require additional maintenance on a monthly basis.

### Maintenance Schedule

Verification by owner	Frequency
<p>Clean off the gear rack with a dry cloth and then apply the clear, multi-purpose grease (P/N 109246) as shown.</p> 	Every month
<p>Check that the swivel seat switch is working. Ensure the unit will not travel until the swivel seat is locked in the riding position.</p>	Every 3 months
<p>Check that the footrest and carriage sensors are working. Ensure the unit stops when it contacts an obstacle.</p>	Every 3 months
<p>Check that the emergency stop button is working (if equipped). Ensure the unit stops immediately when the button is pressed.</p>	Every 3 months
Verification by technician	Frequency
<p>Check the operation of the limit switches. Ensure the unit stops at the required position at the top and bottom of the stairway.</p>	Every 6 months
Check the operation of the overspeed governor	Every 6 months
Lubricate the trolley rollers with silicone grease. Refer to the Installation Guide Maintenance section for the procedure.	As required (if squeaking occurs)
Lubricate the seat swivel system using wheel bearing grease.	As required





**Authorized Savaria Dealer**

# **Stairfriend Stairlift OWNER'S MANUAL**

Part No. 000914  
Copyright © 2020

Savaria Concord Lifts, Inc.  
2 Walker Drive  
Brampton, Ontario, L6T 5E1, Canada  
[www.savaria.com](http://www.savaria.com)

For service or questions about this product, please contact your installing dealer.

DEALER NAME: \_\_\_\_\_

DEALER PHONE: \_\_\_\_\_

